

INSTRUCTIONS FOR THERMOWELD GROUNDING CONNECTIONS - CABLE TO STEEL OR CAST IRON

CS-3

Insert cable into the mold until it touches the surface being welded. Secure to surface using 40-0106-32 chain clamp or a C Clamp.

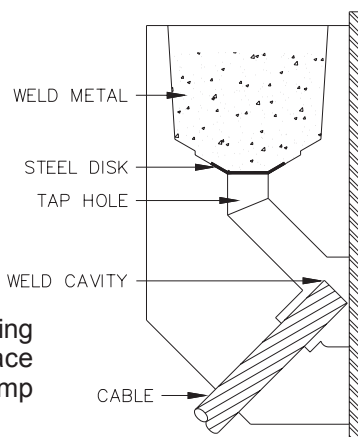
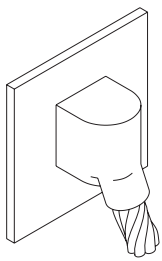

CS-7

For 4/0 cable and smaller, insert cable in mold all the way to the bottom of the weld cavity. For 250 MCM and larger cable, place end of cable to center of tap hole.

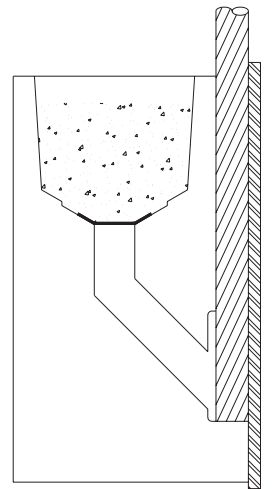
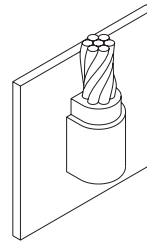

CS-18

Place end of cable under the center line of the tap hole. Secure to surface using 40-0106-41 chain clamp or a C Clamp. Pack cable opening with packing material when necessary.

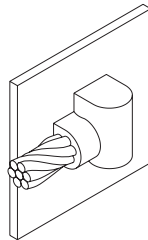
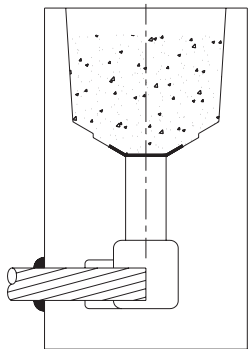

CS-4 & CS-26

Place cable in mold and secure on surface using 40-0106-32 chain clamp or a C Clamp.

NOTE:

Packing material is required on type CS-26 for 1/0 and larger cable to prevent leakage between cable and steel surface.

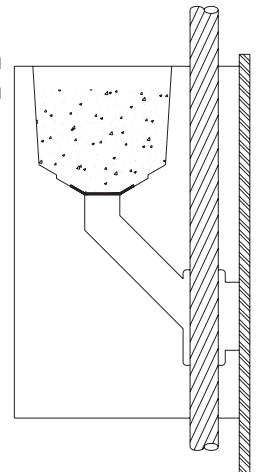
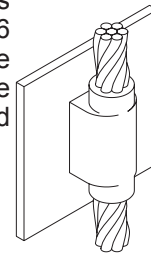

CS-6 & CS-27

Place cable in mold and secure to surface using a C Clamp.

NOTE:

Packing material is required on type CS-27 for 1/0 and larger cable to prevent leakage between cable and steel surface.

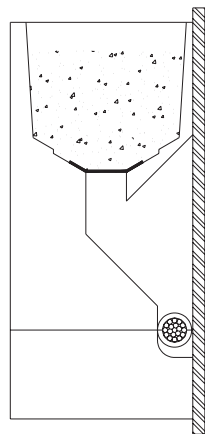
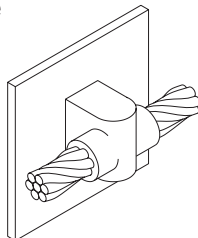

CS-23 & CS-25

Place end of cable at bottom of tap hole. Secure mold to surface using 40-0106-32 chain clamp or a C Clamp.

NOTE:

Packing material is required on type CS-25 for 1/0 and larger cable to prevent leakage between cable and steel surface.

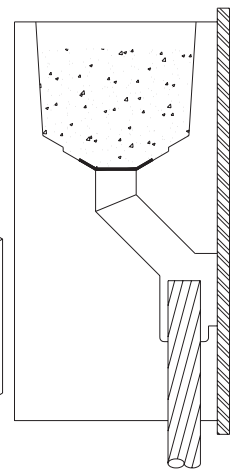
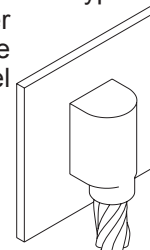

GENERAL SAFETY INSTRUCTIONS

1. Always wear proper clothing, safety glasses and gloves when exothermic welding.
2. Only weld items mold is designed for.
3. Do not use worn or broken molds which could cause leakage of molten weld metal.
4. Make sure that the material being welded fits in the mold properly and that the mold will close tightly around them.
5. Do not alter molds or accessories without factory authorization.
6. Avoid breathing concentrations of smoke, as it may be hazardous to your health.
7. Avoid contact with hot materials.
8. Remove or protect fire hazards in the welding area.
9. Avoid moisture and contaminants in the mold and materials being welded. Contact of molten weld metal with moisture or contaminants may cause weld metal to spew out of mold.
10. When welding to pipe or vessels, you should consider the following:
 - a. the effect welding may have on structural members and thin wall pipe or vessels.
 - b. pipe or vessels that are pressurized or contain (or have contained) flammable, explosive or hazardous materials should be evaluated in the case of a melt-through or hot molten weld metal coming in contact with any flammable, explosive or hazardous materials.
11. Failure to abide by the above and follow welding procedures may result in improper welds, damage to the material being welded or create hazardous situations for the individual.

PREPARATION OF CABLE

1. Cable must be bright, clean and dry.
2. Cable that is saturated with oil or grease must be cleaned. Cable may be cleaned by burning it off with a torch (gasoline blow torch, butane torch, acetylene torch) After burning off oil or grease, a wire brush should be used to remove residue. Wet cable must be dried out. Use a hand torch.
3. Corroded cable must be cleaned. Use the 38-0135-00 cable cleaning brush or a card cloth brush. It is important that the ends of the individual strands are clean. This can best be accomplished by making a fresh cut on the end of the cable.
4. Cable should be straightened before clamping mold in place. Bent or out of round cable will hold mold open and cause leaks.
5. For hard drawn cable or cable under tension, use 38-0330-00 cable clamp.
6. Remove insulation from insulated cable before cutting with hack saw. Otherwise ends of strands will become coated with insulating material which may cause defective welds.
7. FLEXIBLE CABLE
A sleeve must be used when welding flexible cable. 38-0329-00 wrap sleeves are recommended for 300 MCM and smaller cable.

PREPARATION OF STEEL OR CAST IRON

1. Surface to be welded must be bright clean and dry.
2. Remove rust and mill scale with 38-0101-00 rasp, coarse file or grinder.
3. Remove oil, grease or pitch coatings with a solvent or torch.
4. Galvanized surfaces may be cleaned with emery cloth to remove oxide film. It is not necessary to remove galvanizing unless it is double or triple galvanized. Use 38-0331-00 galvanizing bar to regalvanize around weld.
5. Cast iron surfaces must be free from large pits and flaws. For cast iron less than 1/2" thick, do not use larger than a #65 cartridge.
NOTE: Use powder marked C.I. for cast iron. Do not use regular powder.
6. Under some conditions of temperature and humidity the surface to be welded will sweat causing porous welds. This can be eliminated by warming the surface with a hand torch prior to welding.

DO NOT USE cast iron connections on soil pipe (ASTM A-74-82). A test weld should be made on a section of the pipe being used to determine the possibility of detrimental metallurgical effects.

WELDING PROCEDURE

1. Check mold tag for material to be welded and proper cartridge size to use.
2. Make sure all surfaces and conductors are clean, dry and are the proper sizes for the molds application per mold tag.
3. Molds can be dried by heating to approximately 250°F. Molds may be dried with a hand operated butane torch or by firing a charge in the mold before making the desired weld.
4. Position mold onto conductor(s). See front of this sheet for positioning of conductors into mold. Lock mold with handle clamps or frame, whichever is the case.
5. Insert steel disk being sure it is directly centered over the tap hole. Failure to insert disk into mold or failure to seat the disk properly can create an improper weld and may cause mold to spew weld metal.
6. Pour proper weld cartridge(s) into crucible being careful not to loosen all the starting powder while pouring weld metal into mold. Use of wrong weld cartridge can cause improper welds or damage to molds.
7. Close the lid of the mold and place a small amount of starting powder in the ignition pocket.
OR
Insert the EZ Lite® ignitor in the connector of thermOweld EZ Lite Remote™ Unit. Close the lid and place the ignitor in the top opening of the EZ Lite® Lid allowing the connector to rest on the lid.
8. Before igniting, verify conductor positioning and that mold is closed completely.
9. Ignite the starting powder with the flint ignitor. Pull flint ignitor away from starting powder right after trigger is pulled to keep from fouling flint ignitor. (Do not place any exposed body part directly over lid or in front of lid opening.)
OR
Turn the power button to the "ON" position on the EZ Lite Remote™ Unit followed by the "operate" button until the exothermic reaction is initiated.
10. Wait for 15 seconds before opening mold to allow weld metal to cool.
11. To clean the mold, use a natural bristle brush, soft cloth or newspaper before making next weld. On horizontally split molds, use a small diameter rod or screw driver to remove slag from tap hole. Caution should be used when cleaning molds to avoid burns from contact with hot mold.

DO NOT USE WIRE BRUSH TO CLEAN MOLD!

- NOTE:**
1. A fouled flint ignitor may be cleaned by soaking in house hold ammonia.
 2. Proper cartridge size is marked on mold tag and shown on the bottom of the cartridge tube.
 3. Cartridge size is the approximate weight of the powder in grams. When the cartridge size specified is not available, two or more smaller cartridges or part of a larger cartridge may be used. Care should be taken not to mix starting material in-between cartridges.
 4. Handle Clamp adjustments may be made by removing cotter pin and clevis pin and turning eye bolt one turn clockwise to tighten or one turn counter clockwise to loosen.

